

INFO EDUARD

VOL 11 • ISSUE 6 • JUNE 2011



BUILT:

Albatros D.III Oeffag 153
MiG-21MF Egypt

ONE WHOLE
YEAR
TOGETHER!



E-BUNNY
and INFO
EDUARD

Bata & Pi.
©

HISTORY:

Gefechtsverband
Kuhlmeiy and Black12



BRASSIN:

F-16 radar early
1/48 Tamiya



INFO EDUARD

VOL 11 • ISSUE 6 • JUNE 2011

© Eduard-Model Accessories, 2011

FREE FOR DOWNLOAD, FREE FOR DISTRIBUTION!

This material may only be used for personal use. No part of the text or graphic presentations can be used in another publication in any other media form or otherwise distributed without the prior written permission of Eduard Model-Accessories and the authors involved.

Editorial and Graphics - Marketing department, Eduard-Model Accessories, Ltd.



CONTENTS

4 EDITORIAL



release Lysander Mk.III 1/48 ProfiPACK

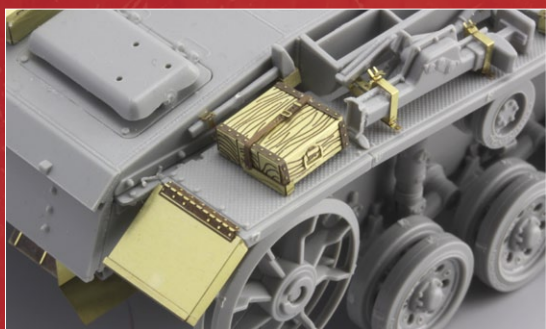

photo-etched details StG.III Ausf.F/8



6 KITS

- 6 Lysander Mk.III 1/48
- 7 Fw 190AD-13 1/48
- 8 Fw 190A JG-54 Grünherz 1/48

9 BRASSIN

AIM-9M/L Sidewinder, F-16 radar early, MiG-29 seat late

10 PHOTO-ETCHED

13 BIG-ED

14 RELEASES

June 2011 releases

15 HISTORY

- 15 The Green Heart close to the Heart
- 21 Gefechtsverband Kuhlmei and Black 12

24 BUILT

- 24 MiG-21MF Egypt 1/48
- 25 Oeffag 153 1/48

26 ON APPROACH

July releases



MiG-29A

eduard

Issued by Eduard Model-Accessories, Ltd.
Mírová 170, Obrnice 435 21
info@eduard.cz
www.eduard.com

EDITORIAL



The moment I finish off the April newsletter, more events worth writing about just keep on happening. The death of Osama Bin Laden right on May 1st carries with it its own symbolism. Incidentally, there were some new helicopters around the event, and I am hopeful that more information will come out about it, at least, more than was printed in the news or what was introduced by Dragon. I think it's a foregone conclusion. Besides being skeptical, society also seems to have a helluva propensity for not being able to keep its mouth shut. Within this context it's unbelievable that we have been able to keep under our belts for two months now the new E-day welcome kit. I consider that quite an accomplishment in and of itself. I am curious to see when it will finally break.

Another volcano has blown its lid. As before, it is in Iceland. A bit of déjà vu. Same as when modelers ask me about future plans. All seem to be surprised that we intend to release a 1/72nd scale Hellcat in August. Originally this was scheduled for July, but for some technical as well as staff reasons it was pushed to August. With that, this Hellcat will be a very fresh and hot new item for the IPMS Nationals come early August. I know that that kind of speed is unprecedented with us, but keep in mind that I have been warning about a quicker release schedule for quite some time now. The Hellcat can be taken as verification that we were serious, and fans of 1/72nd scale can take this as a technological sample of what they can expect from us in this scale, which we will intensively focus on in the future. This Hellcat is the little brother of our 1/48th scale kit, although it is not strictly speaking a scaled down version of the quarter scale kit. Also, some components are redone, hopefully for the better. With other future 1/72nd scale kits, prepared for this new 72nd scale line, the changes will be even more radical, most evident with the Bf 110, which will be significantly simplified. This will not come at the expense of quality, and I do believe that our 1/72nd scale kits will be very well received, and a very pleasant build! Throw a tube of glue into the box, shake it, and out comes a built kit.... well, not quite, but we are getting close!

Those who decide to compare our results at the beginning of our endeavors to the quality we currently are able to achieve, will be faced with an excellent opportunity in August. There will be a unique chance to compare our newest kit with one of the oldest. After pressure from customers as well as colleagues, I have decided to re-release the ancient Tempest kit. Although

the kit can be considered ancient, it hails from the nineties, not really all that long ago. From this comparison, it will be easy to gage that the evolution of our kits has not been all that slow after all. At the time of its release, the kit was met with almost non-critical quiet, maybe much more so than our current kits with which there is frankly no comparison. In any case, it was the first thing we did with which we could embark on the road to higher quality, comparable to the world standard. The re-release of the Tempest will certainly not set its sights quite so high. It's really more of a collector thing. Take it as your last opportunity to add the Eduard Tempest to your collection, at least in the form of the original moldings. In the tradition of the saying 'never say never' I cannot rule out a return to the Tempest as a new item, with our current level of ability. But that would not be a threat for several Eduard years, so take it easy! The current and last incarnation of the kit will be released as a Limited Edition kit, with resin parts, and, of course, color photoetched. The marking options in the kit are probably its most interesting aspect. But, being a British plane, it will not be a marking miracle. In any case, the options are first and foremost for Closterman's aircraft supported by new and, as far as I know, unpublished, information, that should be included in a future newsletter.

The Hellcat is still in the future, and, currently, there are other items to focus on. As the centerpiece of June releases, I would draw your attention to the Limited Edition kit covering the theme of JG 54. It is one of our bigger endeavors encompassing 17 trees allowing the building of two Fw 190s in A-5, A-6 and A-8 versions. The ten offered marking options cover various camouflage schemes of colorful and highly decorated pilots. This will be a great offering for collectors and experts alike. The experts in particular will likely come up with a number of controversial points with respect to the markings. As has become the norm at our firm, we have had a lot of 'expert' debates already in our own little company circle. So, we'll see what the external sources have to offer. As a bonus, we have included the 'Green Heart', and a very nice rendition, too, if I do say so myself!

I figure that the Weekend Edition of the 1/48th scale Fw 190D-13, as well as the Lysander in 1/48th scale, will remain in the shadow of the Fw190. This will probably surprise only the most hardened of Anglophiles. The Lysander is one of a variation on an older item. It hails from the original Gavia kit, which we have released twice since taking over the molds. This ProfiPACK version is not quite as radical as the original release, and although some of the less effective plastic components are offered as resin replacements, their number has been reduced. The same goes for the photoetched brass. We are employing the notion that too much of a good thing is harmful, and having too much resin and photoetched could hurt sales and relegate the kit to the stash instead of the bench. Truth be told, you'd think that who uses no aftermarket accessories is not a true modeler, going by adverts and articles, but reality can be somewhat different.

Well, I described in detail our release schedule for June and August, so what about July? Just another holiday? No, of course not! There are two quarter scale MiGs in our July schedule. For all jet and MiG fans, surely dangerous moment in your life! These MiGs are the MiG-21MF in the Weekend line, and the MiG-29A in the Limited Edition line. While the 21 is a classic Eduard Weekend kit with simple plastic components with decals and instructions, the -29 is the original Academy kit highly supplemented with accessories. It follows last year's releases of the Sukhoi Su-7, Su-22 and Su-25, with similar sets from the Brassin line and photoetched details, with quality Cartograf decals for five marking options. Cartigraf remains the only source for all the Limited Edition and Profipack boxing decals. Brassin details are added for the cockpit shell including the ejection seat, and the tail mounted chaff and flare dispensers. There is a pilot helmet as a special bonus in the Brassin set.

The MiG-29 ejection seat is released independently among June Brassin releases, together with two other sets, the AIM-9M/L Sidewinder and an F-16 radar set. Please avoid the conspiracy theories that we purposely produce simplified kits to open up the market for separately sold accessories, increasing our income. This is a theory I found in a review, and one that I have been intensively thinking about. Well, it makes sense, sounds clever and actually, in a strange sort of way, I am proud that someone would think that we have the resources to go that route. But, it is just that....a conspiracy theory. We simply can not do the plastic parts any better, although that will always be the goal. Yes, I admit we would like to release the accessories simultaneously with their intended kit, but even that is still beyond our abilities. But, we are getting better and better!

Turning to photoetched, our June range of offerings is consistently varied, with five Navy sets in various scales, plenty of sets for aircraft and tanks and two new 1/35th scale fruits and vegetable sets. There are the Sunflowers and Grape Vines sets, and to my mind, these two sets are absolutely cool. Although both sets are so nice, I can still guarantee you that there is absolutely no BIO or EHEC hazard!

The current newsletter format is one year old. Things being what they are, people are used to it, and is considered a normal thing, which in its own way is a measure of success. The Bunnies have been with us a year as well. Even they don't command as much attention as earlier, but every now and then, they peak, and so did the little comic about the MiG-21SMT. The reaction to that was even quite stormy. I don't really feel the need to dive in with my own assessment of weather or not it was silly, and I would leave it up to personal opinion. Take into account that this was our first attempt at something like this in our newsletter, with no previous experience, but it is something that I think we could work with, as a genre. This can even be further applied to some of our other activities, as mentioned previously, and I cannot promise you that at some point in time, something, somewhere, will not quite work out. But I will promise you

that we will continue in our endeavor at further advancement, even at the price of not always succeeding. Who does nothing will not fail. We certainly will continually be doing something.....

True, sometimes it can appear that we are stagnant, as in the case of our new web page. That has been a frustrating experience. In fact, much has been done, and there has been movement in the right direction, and I am hopeful that the end is near, and that the new webpage will present a list of advantages and useful advancement.

We are in Model Brno next week. All our European friends are welcome, as usual. We will show certainly a lot of interesting news, and we all are ready to answer all your questions and promise you all you want! Those of you across the pond, come and see us at the IPMS Nationals in Omaha in early August.

Keep on modeling!

Vladimir Sulc



Lysander Mk.III ProfiPACK Edition

1/48 Cat.No. 8290



Lysander Mk.III SCW, V9287,
No. 161 (SD) Squadron, RAF,
Tempsford AB, 1942



Lysander Mk.III SCW, V9367,
No. 161 (SD) Squadron, RAF,
Tempsford AB, 1944



Lysander Mk.IIIA, V9437, No. 309
Squadron, RAF, Dunino Airfield,
Skotsko, 1942



Lysander Mk.III, T1429, No. 26
Squadron, RAF, Gatwick AB,
1940/41



Lysander Mk.IIIA, V9374, No. 613
Squadron, RAF, Great Britain,
1941



KIT CONTENTS

resin accessories:

- machine gun
- ammunition magazines
- engine air intake

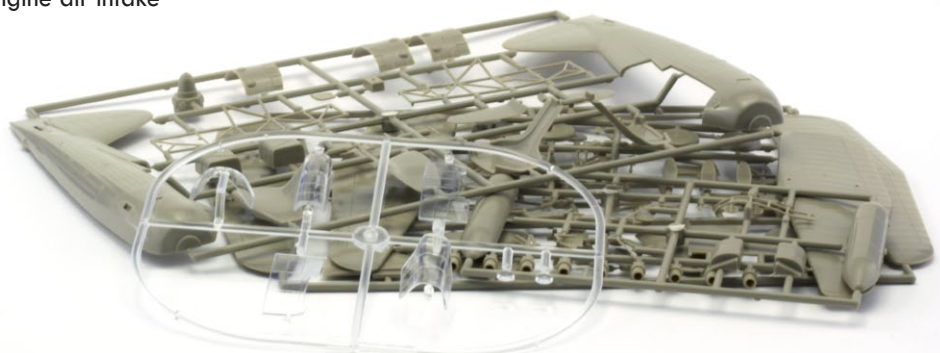

BUY Lysander Mk.III 1/48

Fw 190D-13 Weekend Edition

1/48 Cat.No. 84106



Fw 190D-13/R11, W.Nr. 836017, Stab./JG 26, Flensburg - Weiche, Germany, May 1945

This aircraft had belonged to JG 26 and was captured by the RAF at Flensburg – Weiche airfield on May 5, 1945. It is highly possible that this aircraft was flown by Major Franz Götz, CO of JG 26 (Ritterkreuz holder, 63 victories). Yellow ,10' is said to be Götz's lucky number. The small Ace of Spades badge on both fuselage sides refers to his career in the role of III./JG 53 'Pik As' commanding officer. The small inscription on the lower part of the cowl is not accurately known – the most often mentioned likelihood is 'Kontrolliert', seen on other German aircraft. The R11 designation indicates installation of the PKS 12 autopilot, and the letter 'R' stands for 'Rüstsatz' (,additional set' in German). The WFG factory camouflage scheme was darkened using RLM 82 and RLM 83 colours

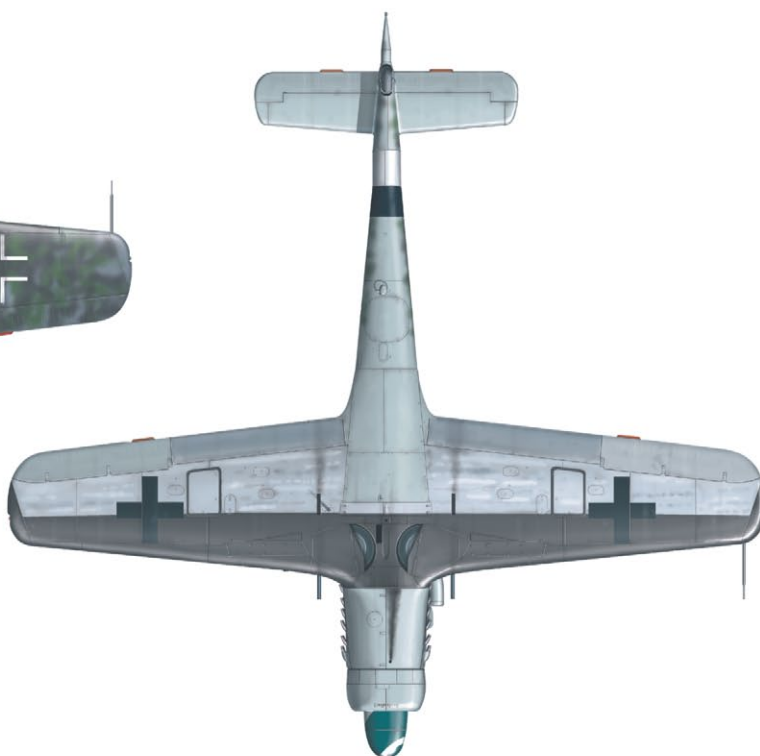
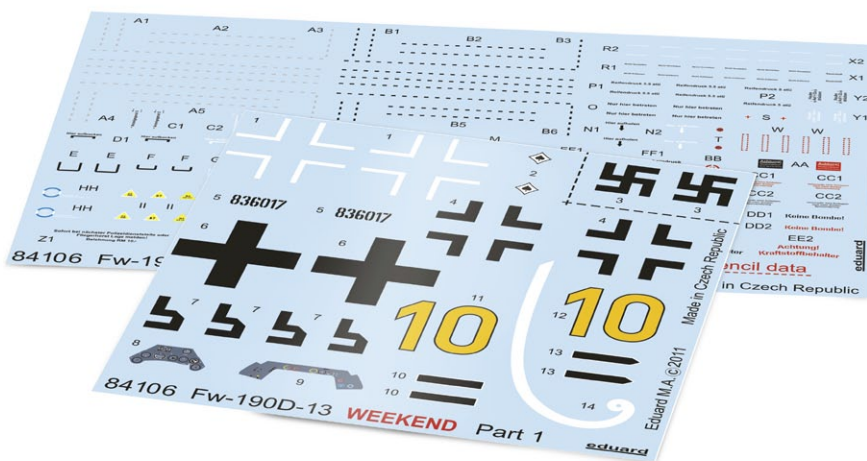

BUY Fw 190D-13 1/48



Fw 190A



Grünherz, 18 mm, (0.7")
Dress Pin

JG 54 GRÜNHERZ



Cat. No. 1155

DUAL COMBO!

1/48

- Box contains parts enabling the building of two models selected from three different versions (A-5, A-6 and A-8) of the Fw 190A used by the famous Luftwaffe fighter unit Jagdgeschwader 54 „Grünherz“
- Eduard masks and photo etched accessories
- 10 colorful marking options for all described versions

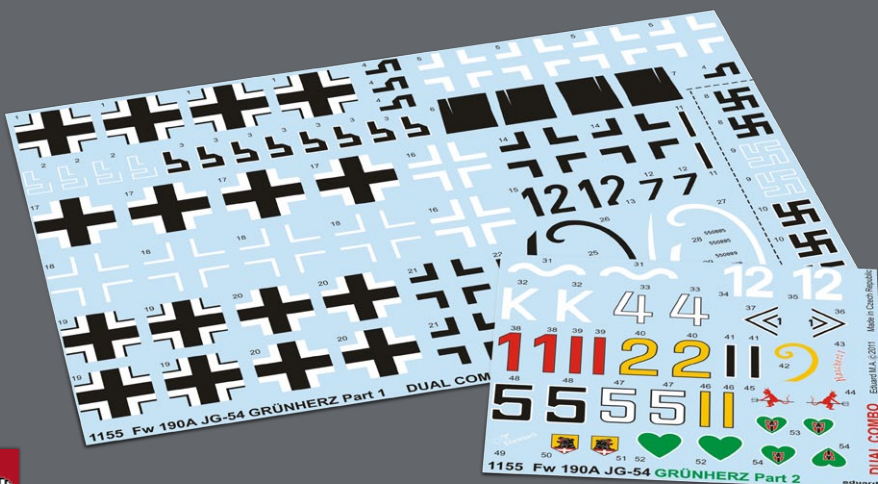

BUY Fw 190A JG54 1/48



648032
F-16 radar early
1/48 (Tamiya)

1/48

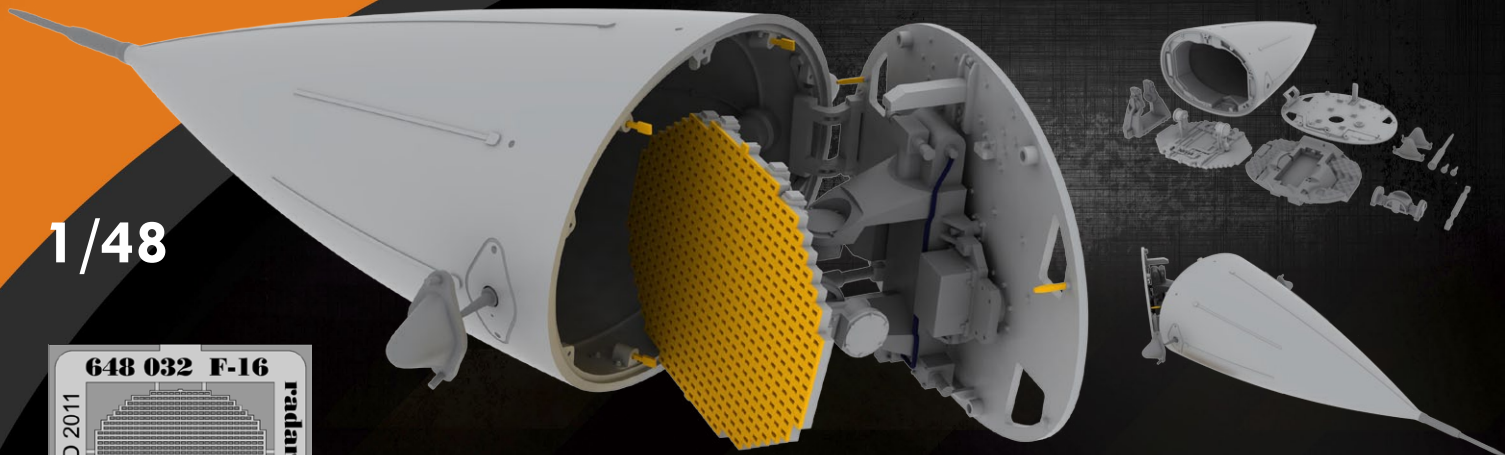

BUY F-16 radar early 1/48



648029
AIM-9M/L Sidewinder
1/48

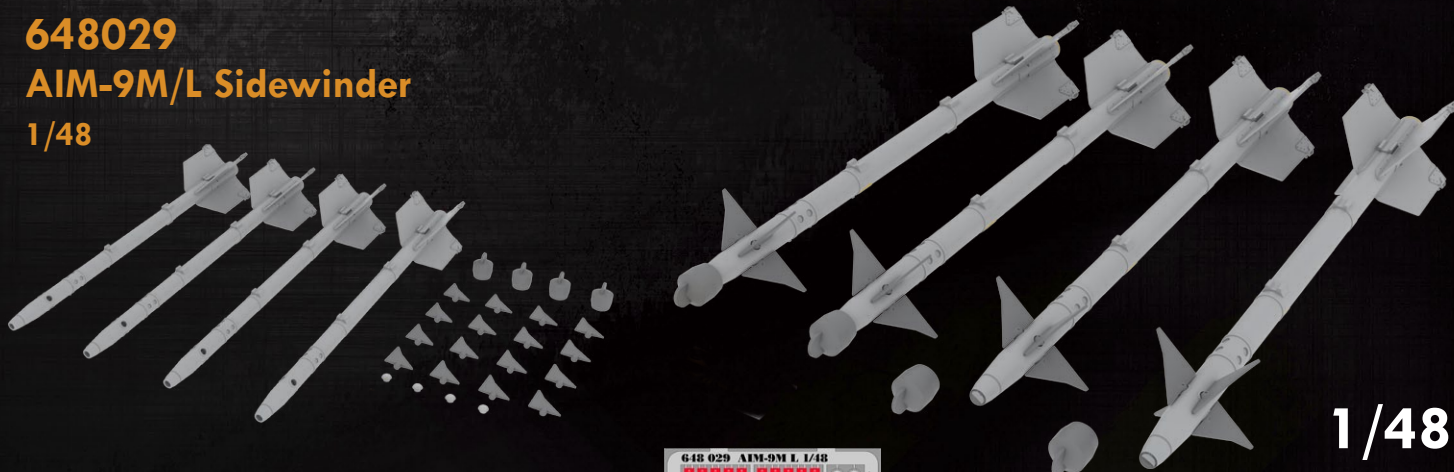

1/48

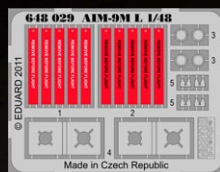

BUY AIM-9M/L Sidewinder 1/48



648034
MiG-29 seat late
1/48 (Academy)

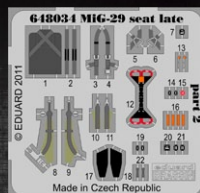
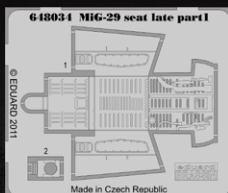

1/48

BUY MiG-29 seat late 1/48



SELECTED

PHOTO-ETCHED



36157
M-7 Mid production deep water fording eq.
1/35 Dragon

36157 M-7 Mid production deep water fording eq. 1/35 Dragon

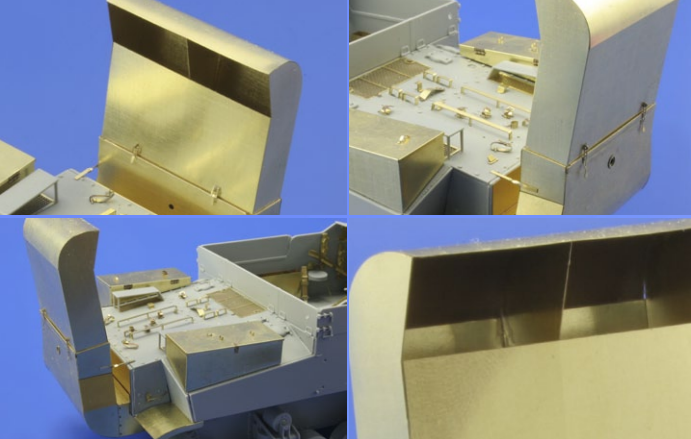

36140 StuG.III Ausf.F/8 1/35 Dragon 6644

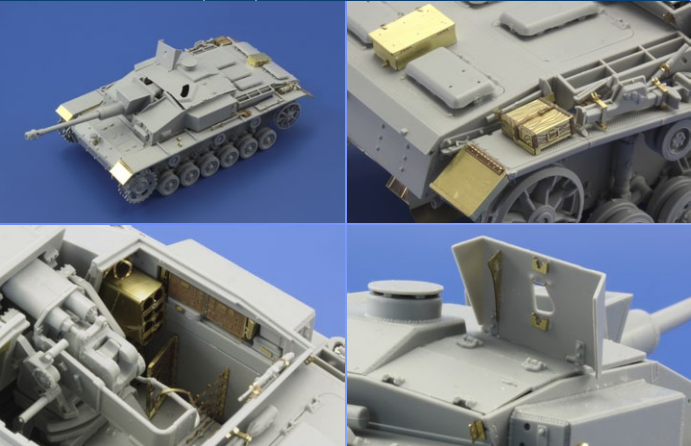

73384 Sea Harrier FRS.1 S.A. 1/72 Airfix



32699 Hawk T1 Mk.53 interior S.A. 1/32 Revell

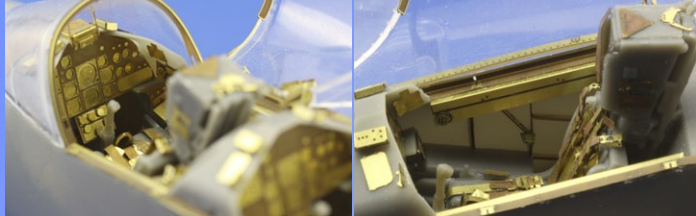

49517 Bf 109E-3 S.A. 1/48 Airfix



72513 Mi-24V Hind E exterior 1/72 Zvezda

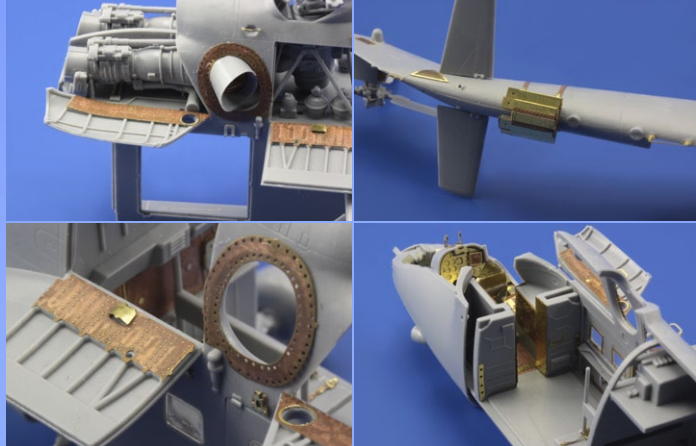

For whole actual
Photo-Etched production
see page 14.

PHOTO-ETCHED

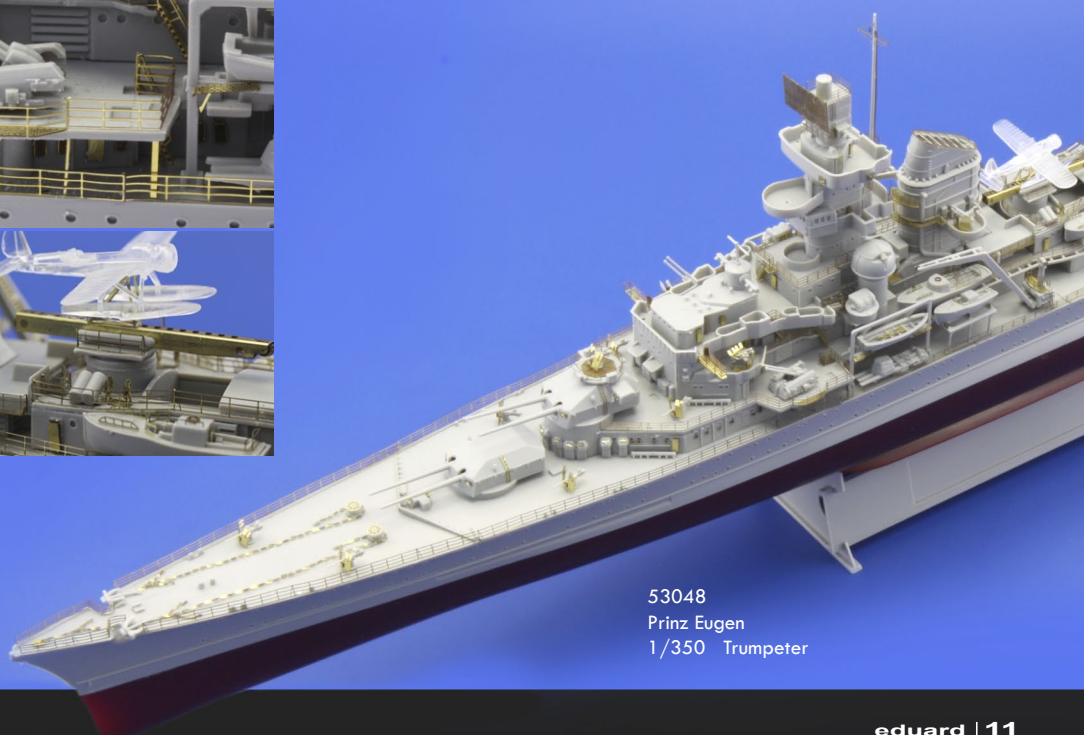
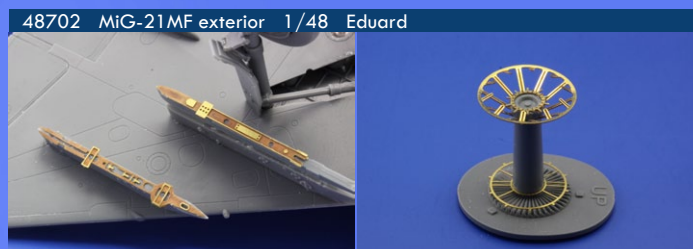
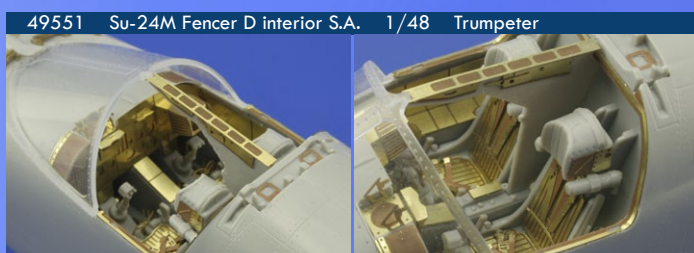
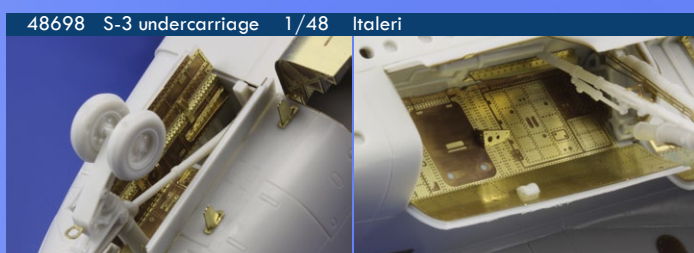

53048
Prinz Eugen
1/350 Trumpeter

PHOTO-ETCHED *flora*

36170

Grapevine

1/35



36168

Sunflowers

1/35

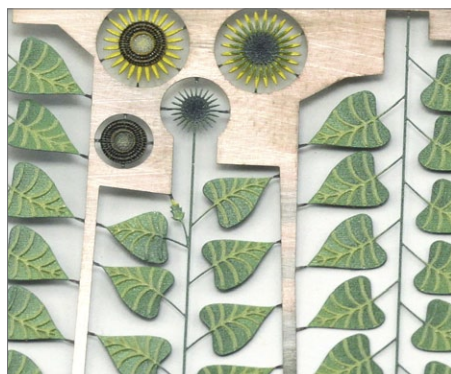

JULY RELEASES...

36152

Wild Flowers, Butterflies

1/35



BIG ED



32255 Su-27UB Flanker C exterior (BIG3301)



48665 Sea King AEW Mk.2 exterior (BIG4948)

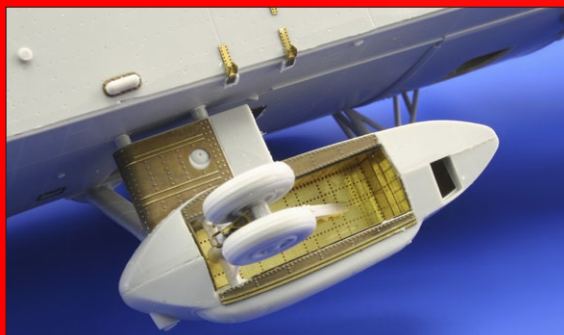

48655 Sea King AEW Mk.2 exterior (BIG4948)



48655 Bf 110D exterior (BIG4949)

BIG3301 Su-27UB 1/32 TRUMPETER*

32253 Su-27/Su-30 Flanker air intakes

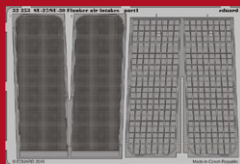

32537 Su-27 Flanker seat



JX100 Su-27UB Flanker C



32255 Su-27UB Flanker C exterior

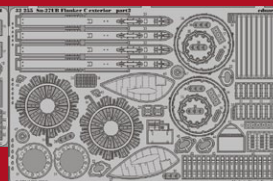
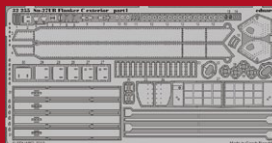

32662 Su-27UB Flanker C interior S.A.



BIG4948 Sea King AEW Mk.2 1/48 HASEGAWA*

48665 Sea King AEW Mk.2 exterior



49510 Sea King AEW Mk.2 S.A.



49009 Remove Before Flight

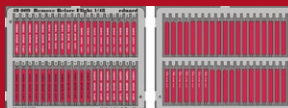

EX308 Sea King AEW Mk.2



BIG4949 Bf 110D 1/48 DRAGON*

48567 Bf 110 workshop ladder

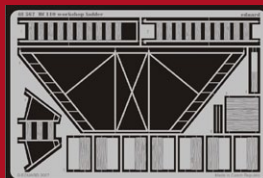

48655 Bf 110D exterior

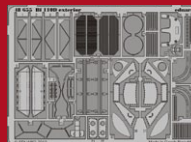

EX302 Bf 110D



49494 Bf 110D interior S.A.

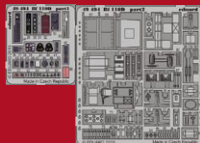

BIG7266 Rafale B 1/72 HOBBY BOSS*

73008 Remove Before Flight

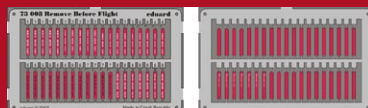

73385 Rafale B S.A.

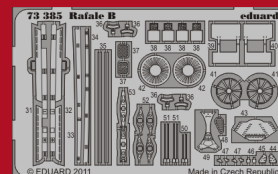

CX267 Rafale B



BUY BIG3301 Su-27UB 1/32 TRUMPETER



BUY BIG4948 Sea King AEW Mk.2 1/48 HASEGAWA



BUY BIG4949 Bf 110D 1/48 DRAGON



BUY BIG7266 Rafale B 1/72 HOBBY BOSS



eduard

MODELY

8290	Lysander Mk.III	1/48	PROFIPACK
1155	Fw 190A JG 54 Grünherz Dual Combo	1/48	LIMITED
84106	Fw 190D-13	1/48	WEEKEND

LEPTY

17521	Life buoy	1/700	
32690	Remove Before Flight - Israel	1/32	
32695	Hawk T1 Mk.53 seatbelts	1/32	Revell
32699	Hawk T1 Mk.53 interior S.A.	1/32	Revell
36140	StuG.III Ausf.F/8	1/35	Dragon 6644
36157	M-7 Mid production deep water fording eq.	1/35	Dragon
36159	Leopard 1A5	1/35	Italeri
36168	Sunflowers/slunečnice	1/35	
36170	Grapevine/vinná réva	1/35	
48697	S-3 bomb bay	1/48	Italeri
48698	S-3 undercarriage	1/48	Italeri
48702	MiG-21MF exterior	1/48	Eduard
49517	Bf 109E-3 S.A.	1/48	Airfix
49551	Su-24M Fencer D interior S.A.	1/48	Trumpeter
49552	Su-24M Fencer D seatbelts	1/48	Trumpeter
49553	RF-5E S.A.	1/48	AFV Club
49556	Mirage 2000D interior S.A.	1/48	Kinetic
49558	Me 262A-1/U4 S.A.	1/48	Hobby Boss
49571	MiG-21MF late interior S.A.	1/48	Eduard
53048	Prinz Eugen	1/350	Trumpeter
53060	Prinz Eugen railings	1/350	Trumpeter
72513	Mi-24V Hind E exterior	1/72	Zvezda
73368	Mi-24V Hind E interior S.A.	1/72	Zvezda
73384	Sea Harrier FRS.1 S.A.	1/72	Airfix

99026	Railings 45' 2 bars short	1/700
99027	Railings 45' 2 bars long	1/350

ZOOMY

33086	Hawk T1 Mk.53 interior S.A.	1/32	Revell
FE517	Bf 109E-3 interior S.A.	1/48	Airfix
FE551	Su-24M Fencer D interior S.A.	1/48	Trumpeter
FE553	RF-5E S.A.	1/48	AFV Club
FE556	Mirage 2000D interior S.A.	1/48	Kinetic
FE558	Me 262A-1/U4 interior S.A.	1/48	Hobby Boss
FE569	MiG-21MF early interior S.A. Weekend	1/48	Eduard
FE571	MiG-21MF late interior S.A.	1/48	Eduard
SS368	Mi-24V Hind E interior S.A.	1/72	Zvezda
SS384	Sea Harrier FRS1 S.A.	1/72	Airfix
TP531	StuG.III Ausf.F/8 interior	1/35	Dragon 6644

MASKY

CX288	Bf 110E	1/72	Airfix
CX289	MB.200	1/72	KP/Kopro
EX326	S-2E/F	1/48	Kinetic
EX332	S-3	1/48	Italeri
EX334	Ta 152H	1/48	Hobby Boss
EX335	Sea Vixen FAW.2	1/48	Airfix
JX125	A-4E	1/32	Trumpeter
JX126	Spitfire Mk.Vb	1/32	Hobby Boss
XT172	M-1097 A2 Cargo Carrier	1/35	Italeri
XT174	SWS with 20mm Flakvierling wheels	1/35	Great Wall Hobby
XT175	Pak 44 128mm wheels	1/35	Great Wall Hobby

BIG-ED

BIG3301	Su-27UB	1/32	Trumpeter
BIG4948	Sea King AEW Mk.2	1/48	Hasegawa
BIG4949	Bf 110D	1/48	Dragon
BIG7266	Rafale B	1/72	Hobby Boss

BUY na e-shop Eduard



Comments and input from J&T

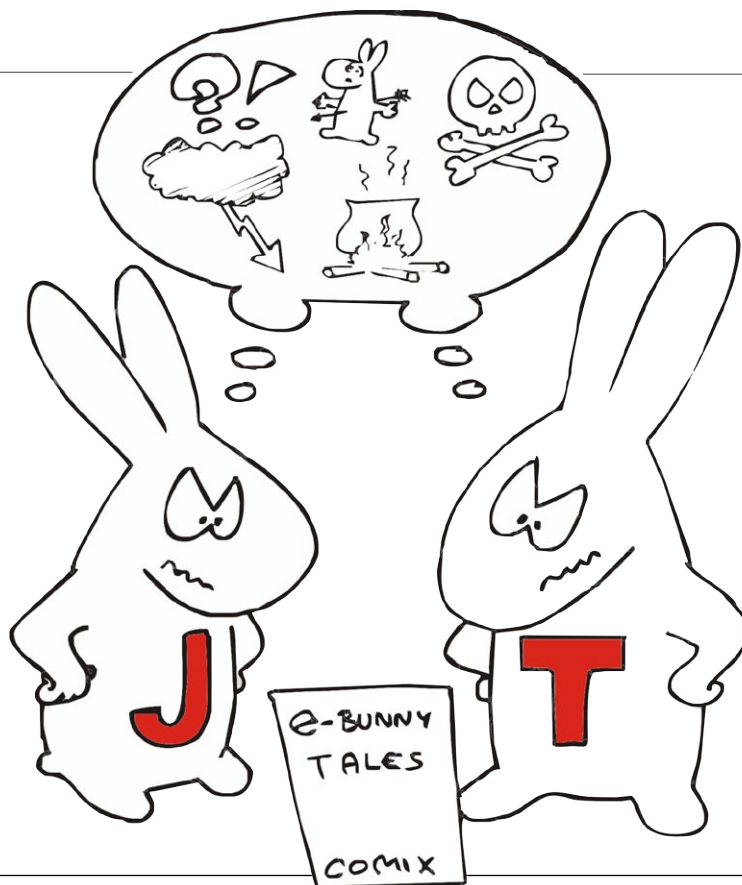

Bobek P.
©

The Green Heart close to the Heart



Jan Zdiarský



Jagdgeschwader 54, which is the subject of Limited Edition kit No. 1155 from Eduard, was formed in 1940, and throughout its service career during the Second World War accounted for over 9000 kills, making it the second most successful fighter unit in the Luftwaffe (after JG 52, with both units gaining the bulk of their victories on the Eastern Front). The unit marking adopted was the Green Heart, a reference to the Thüringen region of Germany, and the birthplace of the unit's first CO, Hannes Trautloft (see Eduard Newsletter, [August 2010](#)). Over various time periods, the Green Heart, together with many other forms of personal marking,

appeared on the fuselages of Bf 109s, and later, Fw 190s flown by this unit. This, coupled with multiple camouflage schemes, offers up an interesting modeling excursion into history. No less interesting are the personnel that with the Fw 190s of JG 54 flew combat with or without the Green Heart on the fuselage. The following is a brief look at the aircraft subjects of the aforementioned kit (except Fw 190A-6 Black ,12', flown by Uffz. Heribert Koller, which is also included as a marking option, but is looked at in greater detail in the article by J. Bobek elsewhere in this newsletter).

Fw 190A-5, W.Nr. 01501501, 1./JG 54, Oblt. Walter Nowotny, Krasnogvard Area, Russia, August, 1943



Green camouflaged Focke-Wulf marked White '4', with a rendering of a goat and inscription 'Rammock', was flown by Walter Nowotny, CO of 1. Staffel I./JG 54, holder of the Knight's Cross, in the summer of 1943. At that time, the 23-year-old 'Nowi', born in the Czech-Austrian border region, was one of the most significant personnel of JG 54 on the Eastern Front spe-

cifically, and the Luftwaffe in general. He died on November 8th, 1944, as the CO of the first German unit equipped with the jet powered Me 262. Up to the time of his death, he was credited with 258 aerial victories, the vast majority of which were achieved on the Eastern Front in the ranks of JG 54.

The camouflage of the illustrated aircraft consis-

ted of two closely toned unspecified greens, one of which was probably RLM 70, and the other mixed from that. These shades were sprayed in irregular fields over the original RLM 74/75/76, which was visible in places through the newer application, and the lower colors remained unchanged, extending up the sides of the fuselage. The widely applied yellow recognition markings, ➔

typical for the time and area of ops, was indicative of the need for the Luftwaffe to differentiate their aircraft from those of the similarly painted enemy. The inscription 'Rammbock' on the left side of the fuselage under the cockpit, needs to be translated more along the lines of the local culture rather than literally, and in this case that would be as a 'virile ram'. The wing armament of this aircraft consisted of only two MG 151/20 cannon, with the outboard MG/FF cannon positions being faired over.

Major Valter Nowotny
(by Petr Štěpánek)



Fw 190A-5, WNr. 01501501, „Rammbock“
(Bundesarchiv)



Fw 190A-5, Oblt. Max Stotz, 5./JG 54, Russia, Spring, 1943

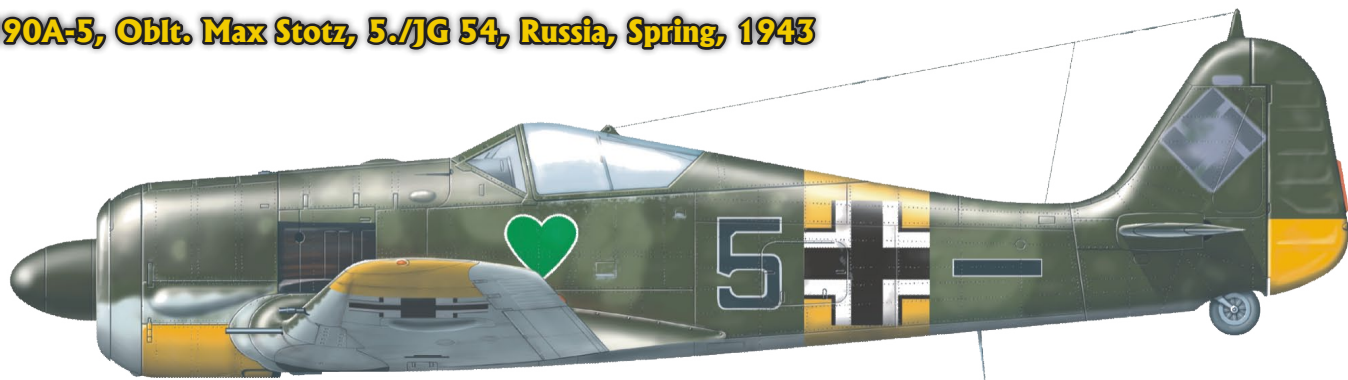

The aircraft depicted here is dated from the winter to summer time frame, 1943, when the Fw 190s of JG 54 went through frequent camouflage scheme modifications that bore little resemblance to the prescribed instructions. Black '5', flown by Oblt. Max Stotz, is camouflaged in a similar way to that of Fw 190A-5 'Rammbock' (Scheme 'A'), consisting of two similar greens, applied over the original scheme of RLM 74/75/76. In this case, this did not include the area of the Swastika or the W.Nr. at the tip of the fin.

A large unknown remains the application of the JG 54 emblem and its II. Gruppe on the front fuselage. Although these are represented in most previous reconstructions, it must be noted that their exact rendering on this bird could not be based on any serious documentation. They could not be backed by photographic resources, nor on any other II./JG 54 aircraft of the same time. That opens up to the possibility that these were not even carried. If they were in fact applied, then the heart emblem would have been carried on both sides under the cockpit, same as

the II./JG 54 marking on both sides of the nose. The 'Aspern Lion' - emblem of II./JG 54, would also have been applied such that it was always facing forward.

The pilot of this aircraft, Oblt. Max Stotz, was credited with 189 kills over the course of over 700 combat flights, and was awarded the Knight's Cross with Oak Cluster. He is still listed as MIA after combat in the area of Viteb in the Soviet Union on August 19, 1943.

Fw 190A-5, 4./II./JG 54 (Jabo), Soviet Union, Summer, 1943



This aircraft is shown as it appeared during service with II./JG 54 as a fighter-bomber and used mainly in attacking ground targets. In this way, fighter units often supported ground units as the opportunity arose. Less often did the role of the Jabo (Jagd-Bomber) see ground attack become the main role within the fighter units. Some examples could be taken from elements of II./JG 54 as summer turned to fall in 1943,

as indicated by the switch from a number code to a letter one. The white color of the 'K' should place the aircraft within the 1st Staffel.

The camouflage consisted of, as with the first two offered choices, two greens applied over the original RLM 74/75/76. Of the green-green scheme, RLM 70 is more prevalent, which gives a final look of almost a monotone, dark green. Fairly uncommon for the given time frame,

the spinner has a white spiral applied to it. Also worth noting is the extension of the undercowling yellow to the oil cooler and oil tank. Non standard are also the crosses on the fuselage and wing undersides that lacked the black outline. These appear to have been applied fresh over the new green scheme.

Fw 190A-6 W.Nr. 550885, Lt. Hans Dortenmann, 2./JG 54, Russia, February, 1944.

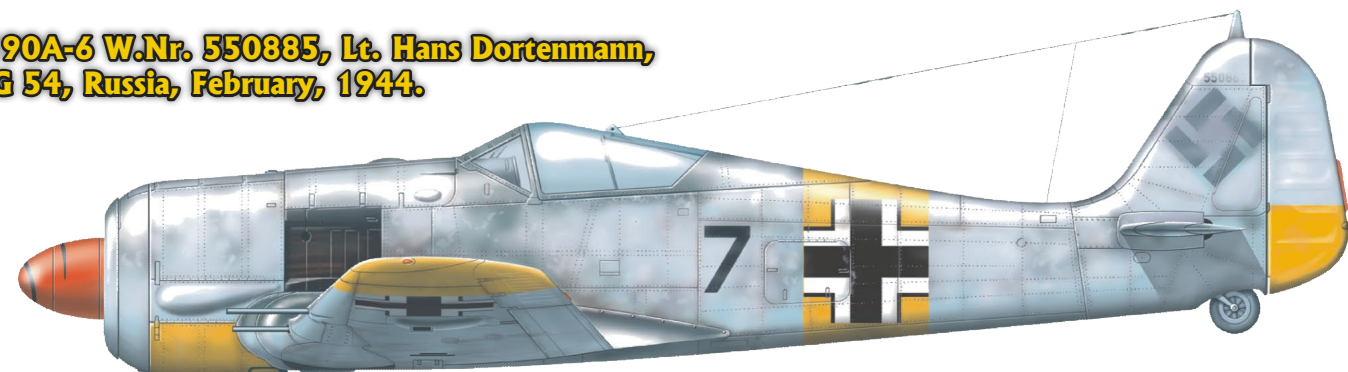

This kit offers the markings for two aircraft flown by Hans Dortenmann. This Fw 190 was painted with washable white paint during the winter of 1943-1944 over the original RLM 74/75/76, partially visible. In this aircraft, Dortenmann

gained his first unorthodox confirmed kill, after colliding with a Soviet fighter at low altitude, likely piloted by Cpt. I. M. Astakhov of the 49th IAP. In the collision, Dortenmann lost much of his left wing. Despite that, he was able to belly in

at Orscha Sud. Before being transferred to the Western Front in the summer of 1944, he would shoot down a further 14 Soviet aircraft, including four II-s Sturmoviks.

Fw 190A-6, 1./JG 54, Russia, Summer, 1943

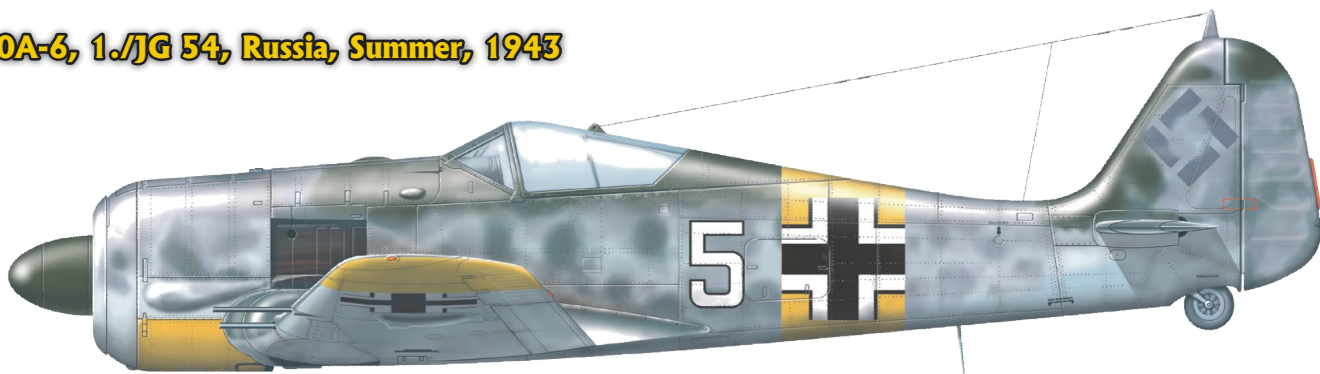

The uniquely painted White '5' of 1st Staffel, JG 54 is attributed to being flown by Walter Nowotny, which he did actually fly, but in all probability was not a personal aircraft of his. The aircraft is interesting first and foremost by its camouflage scheme, as it appeared at a time when the Fw 190s of JG 54 were painted in the original factory scheme of RLM 74/75/76 in combination with the yellow identification markings used on the Eastern Front. The light coloring of the fuselage was darkened with a spray of green, likely RLM 70. Also non-standard was the width of the segments of the upper wing crosses.

As noted earlier, Walter Nowotny was one of the more interesting of personnel to serve with JG 54. Initially, he flew Bf 109s, and switched over to the Fw 190 when the unit re-equipped with this type. The bulk of his victories were gained on the Focke-Wulf, often through extraordinary circumstances. For example, there were nine kills credited to him on August 13th, 1943, and even ten gained on September 1st, 1943 (five which were flamed within a span of twelve minutes). On October 14th, 1943, he became the first German fighter pilot to cross the 250 victory mark. After receiving diamonds to go with

his Knight's Cross and Oak Cluster with Swords, he was called back from his CO of I./JG 54 posting and utilized in a propaganda role, that really did not sit well with a combat fighter pilot and natural hunter. On April 1st, 1944, he was assigned to command the training unit JG 101, and in September, 1944 to the command of Kommando Nowotny, equipped with the Me 262. This unit was activated to develop tactics for jet fighters to combat allied aircraft, and for Nowotny, became his last military, and life's, function...

Fw 190A-6, W.Nr. 550528, Maj. Erich Rudorffer, CO of II./JG 54, Immola, Finland, Summer, 1944

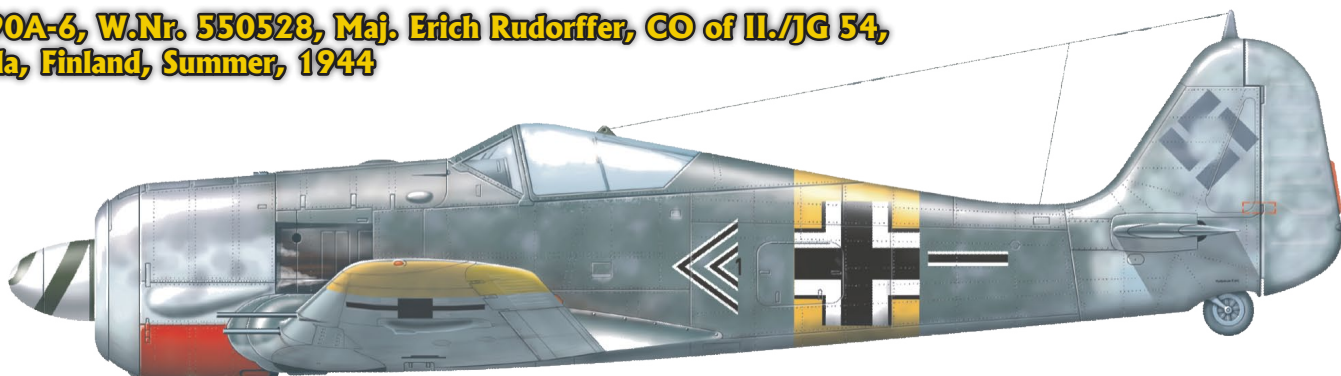

Personal aircraft of the CO of II./JG 54, Maj. Rudorffer, from the summer of 1944 carried a standard camouflage scheme consisting of RLM 74/75/76, which was significantly darkened from nose to tail, likely utilizing a spray of RLM 74. The tactical CO marking, '<<<' was supplemented by a small black '1'. The bottom of the cowling comes across as quite dark in black and white photographs, and was probably red. It is quite possible that the top wing colors were mirror images of each other, much like in that of the aircraft depicted in Scheme F (Black '12', W. Nr. 550889). The crosses on the bottoms of the wings did not carry the usual black outline. The black spiral on the white spinner was a typical marking carried by aircraft of the 4. and 5. Staffel JG 54 in the summer of '44, but in the case of this aircraft, that spiral also may have been red. This aircraft was lost on December 15th, 1944 in combat with Pe-2s and Airacobras, along with its pilot, Uffz. Walter Lewe. Maj. Rudorffer, holder of the Knight's Cross with Oak Cluster and Swords, was CO of II./JG 54 from July, 1943 to the end of 1944. Among his confirmed 224 kills (according to some sources, 222), gained over the course of more than 1000 combat sorties were 58 Il-2s and nine B-17s which he overwhelmed flying the Me 262 Schwalbe as a member of Stab I./JG 7. During his career he was flamed at least sixteen times, nine of which required his use of a parachute.

Erich Rudorffer (archiv autora)



Fw 190A-8, Lt. Hans Dortenmann, 2./JG 54, Villacoublay, France, June, 1944

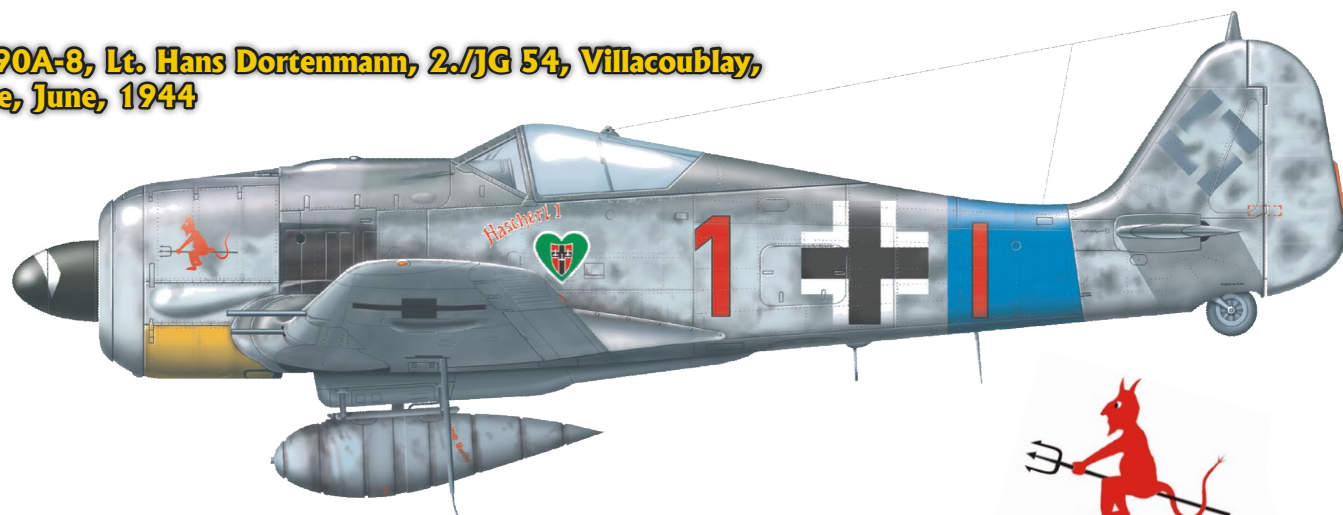

The second of Hans Dortenmann's aircraft to be offered in this article is one used in the Defense of the Reich (Reichsverteidigung). With the illustrated Red '1', Dortenmann flew as CO of 2. Staffel, temporarily subordinate to III. Gruppe, in France during the summer of 1944. At the end of the war, the twenty-three-year-old pilot and holder of the Knight's Cross had 38 kills under his belt, which he gained during the very short span of just fourteen months. During his combat career, he fought against the Soviets, British and Americans.

This aircraft carries a standard scheme consisting of RLM 74/75/76 with a white spiral on the spinner. It also carries the markings of the Defense of the Reich (a blue band for JG 54), and a red vertical band on the rear fuselage denoting service with III. Gruppe. The red color means 2. (or 10.) Staffel, and the number 1 belongs to the Staffel CO. The inscription 'Hascherl 1' under the cockpit was only carried on the left, and together with the devil insignia on the engine cowl are personal markings of the pilot. Whether or not the devil was on both sides has not

Hascherl 1

been identified in photographs, but it is possible. The unit marking for III. Gruppe JG 54 was applied to both sides of the Fw 190A-8. The simplified later variation on the fuselage cross was in this case with a black interior.

Fw 190A-8, 9./JG 54, Villacoublay, France, Summer, 1944

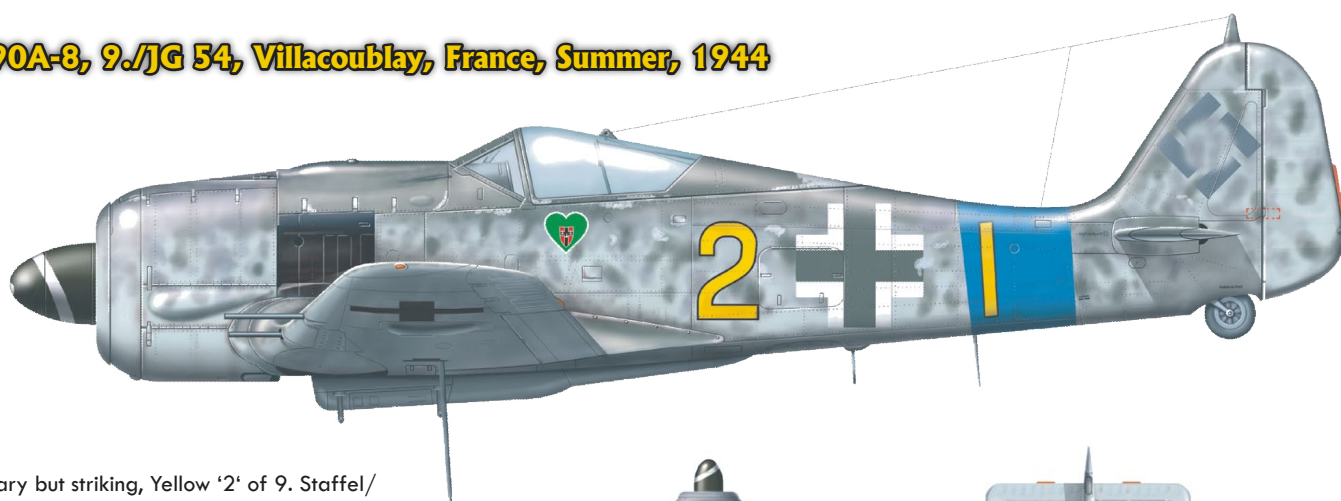

War weary but striking, Yellow '2' of 9. Staffel/JG 54 hails from the days of combat against the Americans within the Defense of the Reich in the summer of 1944. The camouflage of RLM 74/75/76 and the spiral on the spinner all correspond to Luftwaffe standards. The blue rear fuselage band identifies service with JG 54 in the Defense of the Reich system, and the 9. Staffel by the yellow Gruppe marking and fuselage number. The fuselage crosses had their inside sprayed RLM 74. The marking of III./JG 54 was found on both sides of the fuselage. III./JG 54 operated on the Western Front from French and German airfields after being reassigned from Smolensk in February, 1943. The unit's pilots protected defeated territory from allied fighter sweeps and bombing attacks. During May and June, 1944, the unit turned in their Bf 109s for Fw 190s, which they used in the Luftwaffe's and Wehrmacht's attempts to stem the tide of the allied invasion of Normandy. Later, III./JG 54 was tasked with the priority of defending against attacks of the USAAF, usually in combat against allied escort fighters. The unit's attack against American bomber formations are also not to be forgotten.

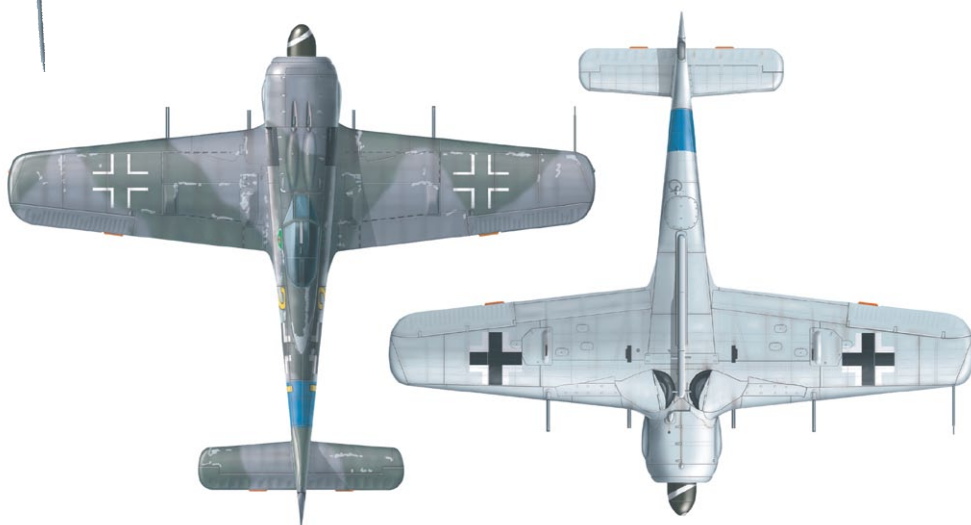

Fw 190A-8, 13./JG 54, Villacoublay, France, 1944-45

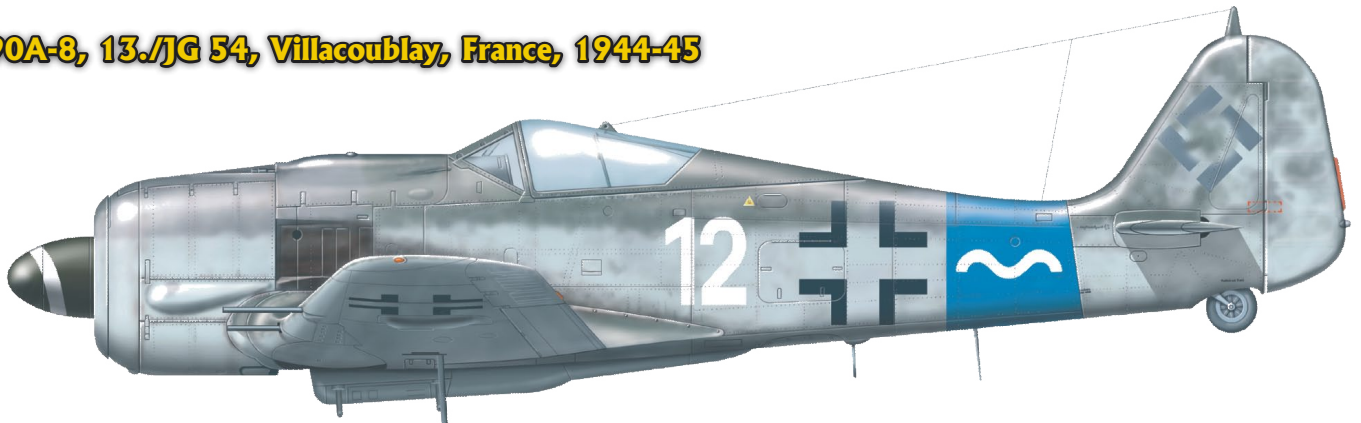

The camouflage scheme and the rendering of the national insignia, documented on the later A-8 variant, apply to this aircraft of IV. Gruppe JG 54. The wavy demarcation between the RLM 76 color from those of the darker shades on the upper surfaces (RLM 74/75) is located fairly high up and gives the aircraft a decidedly light appearance. The national insignia are the simplest version of the later cross type. JG 54

service is indicated only by the blue fuselage band, which adorned the aircraft of the units within the Defense of the Reich system. The white wave marking then indicates the IV. Gruppe and the white number the 13. Staffel.

IV. Gruppe JG 54 flew from air fields in Eastern Prussia and later, from September 1944, in Germany. At this time, the unit was commanded by Maj. Wolfgang Spate (Knight's Cross with

Oak Cluster, 99 kills, best known for his service with JG 400 equipped with the Me 163 rocket fighter), who was replaced in October, 1944, by Hptm. Rudolf Klemm (Knight's Cross, 42 kills). IV. Gruppe was the only component of JG 54 that, after re-equipping with the Fw 190, exclusively flew the 'A' variant up to the end of the war.

SOURCES:

- Jan Bobek, Ota Jírovec (s díky za konzultace)
- Peter Rodeike, Focke Wulf Fw 190A, Fw 190D, Ta 152
- Luftwaffe im Focus 1/2002; 11/2007
- Bundesarchiv.de
- rlm.at (rodinné fotografie Hanse Dortenmanna)
- REVI č. 51
- Bergström, Pegg, Luftwaffe Colours, Vol.3, sec. 4; Vol.4, Sec. 3
- Kagero, Fw 190, vol. 1



Gefechtsverband Kuhlmei and Black 12

Jan Bobek



Following article draws largely from my article published in the journal REVI No. 51. For those keen readers able to understand Czech I highly recommend the read if you want to know more details about the following story. Jagdgeschwader 54 „Grünherz“ is best known for its deployment on the Eastern Front, particularly in the area south of Leningrad (now St. Petersburg). However, various parts of JG 54 came few times also to southern Finland. Probably the best known example is the deployment of JG 54 in the Gefechtsverband Kuhlmei.

II./JG 54 under the command of Major Erich Rudorffer was transferred on 16. June 1944 from Petseri (Pskov) in Estonia to South Finland. At that

time the unit consisted of 3 Staffels (4. to 6./JG 54), but only 2 were sent to Finland (4. and 5. Staffel). Their main airbase was Immola in southeast Finland. The II./JG 54 was quite strongly equipped. It possessed 50 Fw 190s including 30 modern Fw 190 A-6 while the rest were mainly A5 and A-4 versions.

II./JG 54 was part of task force under the command of Stukaflieger Kurt Kuhlmei (500 missions, RK). This task force that carried his name (Gefechtsverband Kuhlmei) was composed from several different units. Their task was to help Finns to defend Southern Karelia and along with II./JG 54 fighters utilized also Stuka dive bombers of I./SG 3, ground attack Fw 190s of I./SG 5 and reconnaissance Bf 109s of I./NAGr 5. Logistics was covered by TGr 10's Savoia-Marchetti SM.81 flown by Italian crews.

Soviet offensive started on June 9 and at the beginning Finns had to defend themselves. Aircraft of GV Kuhlmei landing in Immola was quite unexpected by some Finnish airmen. This could be found in book *Fighter over Finland* by E. A. Luukkanen. Deployment of this task force was significant support for the Finns. For approximately 40 days of a main deployment (SG 5 was active in this area even in August) this Gefechtsverband's fighters shot down 126 planes during 984 sorties and ground attack crews threw 709 tons of bombs.

One of the JG 54 pilots arriving to Finland was Uffz. Koller. At that time he had almost 20 victories to his credit and was attached to 5. Staffel. He was considered as one of experienced pilots and his Staffelkapitän (at that time Oblt. Wolfgang Schilling, 63 v., RK) often asked him to lead 4 ship or 2 ship formations.

Uffz. Koller flew one mission in the afternoon of June 17. He used machine with marking "black 12". In this part of WW II it he was not allowed to have a personal machine, however he performed with this very "Black 12" so far 21 missions



Hauptmann Kurt Kuhlmei (left) having conversation with soldiers (one Finnish and two Germans). For his duty in Luftwaffe he was awarded by Knight Cross. At the end of WWII he served as a CO of SG3 and SG 2, while number of his combat missions went over 500. After the war he became to be the very first German airman to be trained in USA as a jet pilot. Then he served in several posts in the NATO Bundesluftwaffe, including CO of 5th Luftwaffendivision.

during May and June 1944 including about dozen combat sorties. The rest were liaison, training, test and other flights.

He took off from Immola at 16.58 and shortly after 17.30 his flight engaged 10 Jak -9 fighters. He shot down one of them at 17.40 in grid 26 Ost-91/3/8/2 (aprox. NE of Perkjärvi). H. Koller hit enemy fighter 500 meters above ground level. The victory was witnessed by Lt. Heinz Wernicke (117 v., RK) who shot down 15 minutes later an Airacobra near Rautu (Sosnovo) 300 meters above the ground. The tail of Koller's machine was hit during the combat, but he was able to reach Immola very soon and safe. At Immola Koller received congratulations from his wingman Ofhr. Hanns-Veit von Oberritz (later secretary of JG 54 members under the German fighter pilots association). It was Koller's 20th victory which was in frame of 5th Staffel



Finnish soldier helping with maintenance of Fw 190 A-6 „white 4“ from 4./JG 54 on the Immola base.

Photo above: Junkers Ju 87 D „Stuka“ from 1./SG 3 (part of the Gefechtsverband Kuhlmei) on its stand at the south area of the Immola base, summer 1944.



Immola airbase, Finland, 17th June 1944. Heribert Koller sits in cockpit of „black 12“, while Oberfähnrich Hans-Veit von Oberrnitz congratulates him for a recent victory. After 60 years, when I have shown this photo to Heribert, he remembered this situation clearly.

supported by witness report. Moreover there was also Luftwaffe photographer who took shots how Koller sits in cockpit of “Black 12” receiving congratulations from his wingman. He also photographed group of personnel next to tail of the very same aircraft carrying W. Nr. 550 889. Mr. Koller remembered after 60 years the action of the photographer, but he has never seen the photos in the meantime. After my analysis resulted in the impression that 550 889 must be “Black 12” of Mr. Koller, I showed him the photos. He was extremely excited and confirmed that indeed it is him the cockpit and it is his “Black 12”. The aircraft had to be ferried to Estonia next day. After take off at 8.45 from Immola he was going to stop in Helsinki to refuel. Over the Gulf of Finland he noticed a lone IL-2 attacking a passenger or cargo ship. After Koller’s first burst the gunner thought it better to jump out of the plane but his parachute caught in the tail of the IL-2. The Soviet pilot turned south towards his base in Lavansaari trailing the gunner behind him. After a while the pilot did a sharp turn to free the gunner who then landed safely on a small island. H. Koller downed the bomber with one burst (at 9.20). Upon approach to Helsinki the clouds/fog were almost at ground level. After several unsuccessful hair-raising landing attempts H. Koller decided to bail out (at 9.45) and barely avoided HV wires during his descent on the parachute. The engagement with IL-2 took place according to H. Koller somewhere around Kotka and bomber crashed approx. halfway to the island in the south (supposed to be Lavansaari). Soviet ground attack units lost 8 IL-2s and 7 crews (including one pilot awarded with HSU) on June 18 over Gulf of Vyborg and G. of Finland. According to details provided by K.-F. Geust all losses were officially credited to anti aircraft artillery, that was however quite frequent Soviet administration trick how to hide some losses



Heribert Koller

Heribert Koller was born in 1920. Entered Army in 1939. Part of his air training was performed also in former Czechoslovakia. In January 1943 joined 6./JG 54 (II./JG 54) on the eastern Front. Served also with Stab II./JG 54 under famous Assi Hahn. Later transferred to 5./JG 54. In winter 1944/1945 served as instructor in Austria (Luftwaffe student pilots were more dangerous than Soviet pilots)

Victories: 49 confirmed by 5./JG 54 and 1 more by 6./JG 54
 16 of his victories were Il-2 Sturmoviks
 Last victory: Jak 3 on April 9, 1945 in Kurland

Last flight (nr. 1236) on May 8, 1945 – 2 hours and 40 minutes evacuation flight from Kurland to Flensburg (including passengers inside of his Fw 190). Awarded among others with German Cross in Gold and also Finnish Freedom Cross 4th Class.

(photo: H. Koller via J. Bobek)



Discussion close to tail of the „black 12“. Mr. Koller believed, that it's him who stands back to the photographer.



Ground personnel of Schlachtgeschwader 3 (part of Gefechtsverband Kuhlmei) spending some spare time playing cards.



Finnish soldiers helping to load 20 mm ammo for Fw 190 A-6 „white 4“. Note the small number „1“ on the engine cowling, which suggests, that the engine possibly came from another plane.



Finnish ground crew helping with transport of bombs for camouflaged Stukas from SG 3 (part of Gefechtsverband Kuhlmeij), Immola base.

caused by enemy fighters. All 8 “Sturmoviks” belonged to Baltic Fleet Air force (VVS KBF) which performed missions over the Gulf of Finland against Finnish ports, shipping and coastal batteries. From the crash sites indicated by VVS KBF the closest to Koller’s victory is island Seiskari. About 10 km north of this island (called Seskar by Soviets) crashed the 7. GShAP crew gv. ml. lt. N. I. Pukhin/ml. ser. V. P. Zaharov. It is highly probable that they are victims of H. Koller.

Most of the fight around ships on June 18 was near Koivisto where evacuation missions were performed. During the morning Soviet aircraft made huge effort to attack Axis ships. Evacuation was covered by 4 patrol boats of 2. Vm-vLv and six German AF barges. Finnish fighter units were busy over the area from 5.15 am until 9 am claiming 6 Soviet aircraft including 1 Il-2. According opinion of Finnish navy historian J. Aromaa the burning ship may have been small coastal tanker Shell-4. It was the fuel depot of 1. Motor Torpedo boat flotilla. The ship left Uuras harbour during the night 17/18.6. trying to get into Pitkäpaasi area before dawn. The ship was attacked by „dive bombers“ (could be also Il-2), caught fire and sank near Orisaari island.

Mr. Koller was transported on June 19 with an airplane to Petseri and on June 20 ferried new aircraft (fuselage marking “3”) via Reval and Helsinki to Immola. Back with his unit he realized that his wingman von Oberritz was shot down and MIA day before. Il./JG 54 also lost experienced Lt. Hellmut Grollmuss (75 v., RK) on the same June 19. His body was found later by Finnish troops.

The “Black 12” was found in early 2006 during excavations on perimeter of Immola airfield. Thanks to Mr. Seppo Sipilä and other Finnish aviation enthusiasts I was pleased to mediate contact to Mr. Koller. The crash site, wreck of “Black 12” and her former pilot were reunited in September 2006 which was a special event for all participants.

An unusual historical photo was created in order to blend past and present picture of famous Helsinki-Malmi airfield building <http://www.pelastamalmi.org/fi/uutisia/koller.html>

Many thanks for help with the article goes to Mr. Koller and his wife. Many thanks also to REVI magazine, Jaroslav Hradec and Milan Šindler. Great support came Jari Aromaa, Hugo Broch (JG 54), Petr Dousek, Karl-Fredrik Geust, Tomas Haladej, Martti Kuivalainen, Pentti Manninen, Matti Salonen, Kari Stenman, Pavel Türk and Milos Vestsik.

Photo credit: Bundesarchiv, H. Koller

SOURCES:

- Aromaa J.: <http://www.hut.fi/~jaromaa/Navygallery/index.htm>
- Keskinen K., Stenman K.: SIH 18 LeR 3, Lovisaa, 2001
- Keskinen K., Stenman K.: Suomen Ilmavoimat (VI) 1944, Espoo, 2008
- Koller H.: victory list of 15. 5. 1945
- Koller H: Soldbuch (temporary copy)
- Koller H.: Log book pages 53 a 54 via M. Salonen
- Luukkanen E. A.: Fighter over Finland
- Malmi, airport, log book 18. – 20.6.1944 via Matti Salonen
- Obermaier E.: Ritterkreuzträger der Luftwaffe, Band I. Jagdflieger, Mainz, 1989
- Rodeike P: Focke Wulf Jagdflugzeug, Eutin, 1998
- Valtonen H.: Luftwaffen Pohjoinen Sivusta, Jyväskylä, 1997
- Valtonen H.: Lento-Osasto Kuhlmeij, Jyväskylä, 1991
- Wood T.: <http://tonywood.cjb.net/>



Fw 190A-6 W. Nr. 550889, 5./JG 54, Immola, Finland 1944



BUY Fw 190A JG54 Grünherz 1/48

BUILT

MiG-21MF

MiG-21MF No.7628, Egyptian Air Force



Built by Jiří Brůna.

BUY MiG-21MF 1/48



Albatros D.III Oeffag 153



BUY Albatros D.III Oeffag 153 1/48

Built by Jiří Brůna.

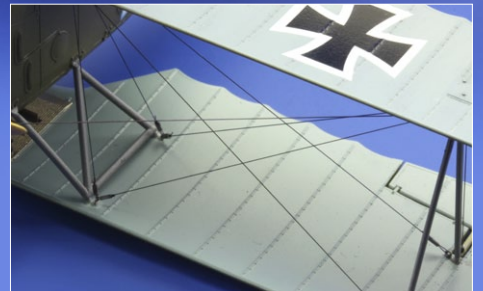



MiG-29A



SINGLE SEATER

1/48

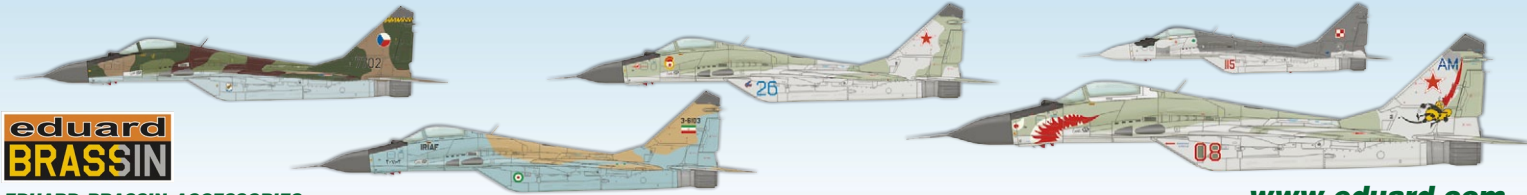

eduard BRASSIN

EDUARD BRASSIN ACCESSORIES

www.eduard.com

BIG ED

JULY

- | | | | |
|---------|-------------|------|------------|
| BIG3302 | Ar 196 A-3 | 1/32 | Revell |
| BIG4950 | Bf 109F-2 | 1/48 | Zvezda |
| BIG4951 | Tornado ADV | 1/48 | Hobby Boss |
| BIG7267 | B-17G | 1/72 | Revell |

eduard BRASSIN

JULY

- 648033**
F-16 radar late
1/48 Tamiya

MODELY

JULY

- 1157**
MiG-29A
1/48 LIMITED EDITION

- 84125**
MiG-21MF
1/48 Weekend

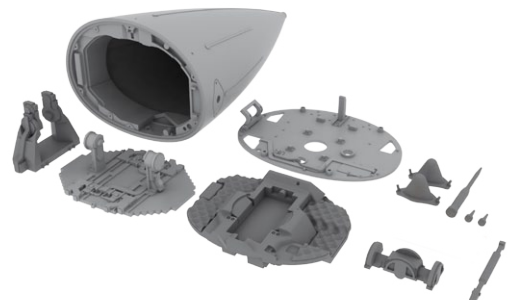
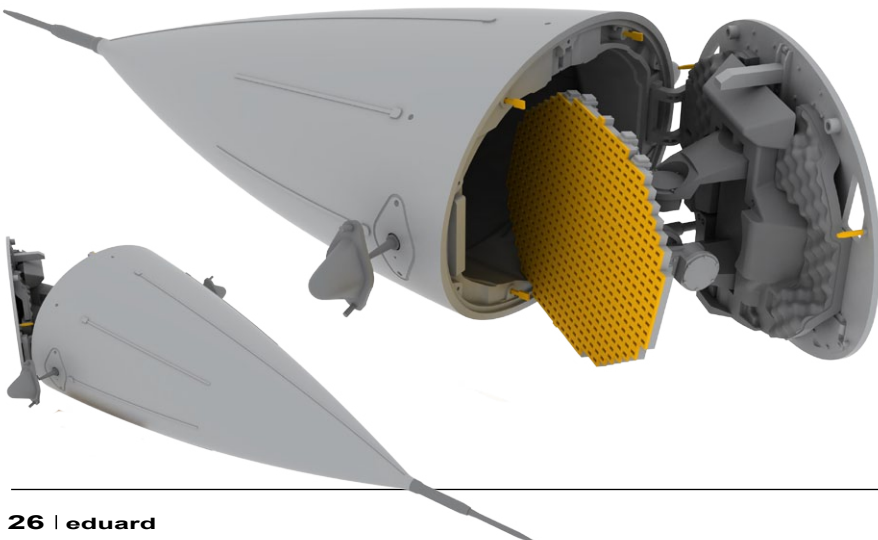

PHOTO-ETCHED

JULY

PE-SETS

17027	USS Nimitz CVN-68 (2005)	1/700	1/700	Trumpeter	49528	Tornado ECR seatbelts	1/48	Hobby Boss
17520	Life buoy	1/350	1/350		49550	PC-6/AU-23A S.A.	1/48	Roden
32277	Hawk T1 Mk.53 exterior	1/32	1/32	Revell	49564	S-2E interior S.A	1/48	Kinetic
32282	Bf 109E-4 exterior	1/32	1/32	Dragon/Cyber Hobby	72520	EF-2000 ladder	1/72	
32685	F-16I SUFA seatbelts	1/32	1/32	Academy	73386	Sea Harrier FA2 S.A.	1/72	Airfix
32692	F-16I SUFA interior S.A.	1/32	1/32	Academy	73388	Bf 110C S.A.	1/72	Airfix
32701	Bf 109E-4 interior S.A.	1/32	1/32	Dragon/Cyber Hobby	99021	Railings 45' 3 chain bars short	1/700	
36152	Polní květiny, motýli	1/35	1/35		99022	Railings 45' 3 chain bars short	1/350	
36163	Nashorn ammo boxes	1/35	1/35	AFV Club	ZOOMS			
36164	Nashorn	1/35	1/35	AFV Club	33080	F-16I SUFA interior S.A.	1/32	Academy
36166	IDF Merkava Mk.IV basket	1/35	1/35	Hobby Boss	33089	Bf 109E-4 interior S.A.	1/32	Dragon/Cyber Hobby
36172	IDF Merkava Mk.IV	1/35	1/35	Hobby Boss	FE523	Tornado ECR interior S.A.	1/48	Hobby Boss
36173	IDF Merkava Mk.IV armour shields	1/35	1/35	Hobby Boss	FE550	PC-6/AU-23A S.A	1/48	Roden
48675	Tornado ECR exterior	1/48	1/48	Hobby Boss	FE564	S-2E interior S.A.	1/48	Kinetic
48696	S-3 exterior	1/48	1/48	Italeri	FE566	B5N2 S.A.	1/48	Hasegawa
48699	S-2E bomb bay	1/48	1/48	Kinetic	SS386	Sea Harrier FA2 S.A.	1/72	Airfix
48700	S-2E undercarriage	1/48	1/48	Kinetic	SS388	Bf 110C interior S.A.	1/72	Airfix
49523	Tornado ECR interior S.A.	1/48	1/48	Hobby Boss	TP534	Nashorn radio	1/35	AFV Club



17027 USS Nimitz CVN-68 (2005)
1/700 Trumpeter

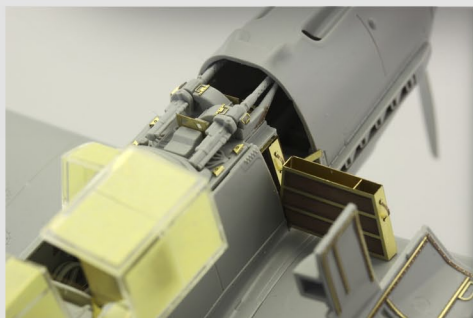

32282 Bf 109E-4 exterior
1/32 Dragon/Cyber Hobby

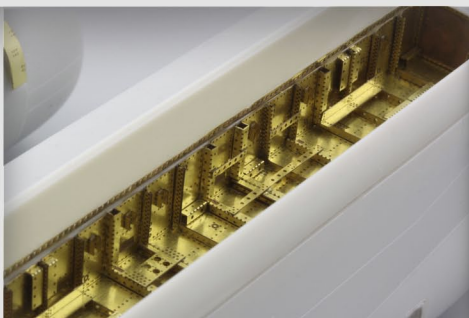

48699 S-2E bomb bay
1/48 Kinetic



49550 PC-6/AU-23A S.A.
1/48 Roden



36163 Nashorn ammo boxes
1/35 AFV Club

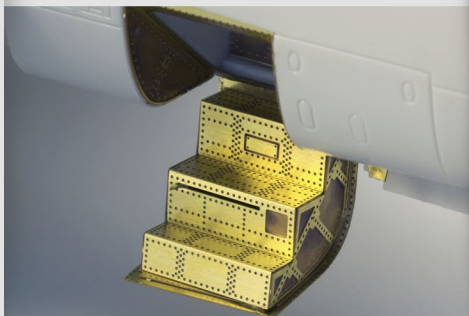

48696 S-3 exterior
1/48 Italeri



73386 Sea Harrier FA2 S.A.
1/72 Airfix

INTERNATIONAL SCALE KIT EXHIBITION

IPMS
CZECH REPUBLIC

eDay



UNIQUE SHOW FROM THE WORLD OF SCALE PLASTIC KITS, INSPIRATION FOR CREATIVE KIDS AND PARENTS. COMEBACK OF YOUR CHILDHOOD.

1. 10. 2011

9.00-18.00

**SHOPPING CENTER
GALLERY BUTOVICE**

PRAGUE

EXHIBITORS AND RESELLERS
OF HUNDREDS OF MODELS

ENTERTAINMENT FOR VISITORS

EASY ACCESSABILITY, FREE PARKING, SNACK-BAR

TUBE  **B** Radlicka 520/117, Prague 5
STATION NOVE BUTOVICE underground parking lot

GPS: 50°2'50.9"N, 14°21'17.7"E

WWW.EDAY.CZ



PRAGO
PLAĀAT

eduard



European get-together for plastic scale modellers and contest exhibition

Junior Plastic Scale Modeller's Championship of the Czech Republic

MODELLBRNO 2011



June 18, 2011, 9:00-17:00

Brno Exhibition Centre, Czech Republic

Exhibition with hundreds of plastic scale model kits • Workshops
Large accompanying programme • Many traders selling model kits and accessories
The very rare and famous „Butch of the Year“ competition in throwing finished models

www.modellbrno.cz

GENERAL PARTNERS AND ORGANIZERS



B | R | N | O | I



GENERAL SPONSORS

AZ Model • Bílek Hobby Kits • Lifecolor.cz • Eduard Model Accessories • junek-R • Modelartikl.cz • MPM Production • Nordland Models • OD Vágner • Transtech Tooling

SPONSORS

Catering Infinito • CMK • ExtraTECH • Hauler • HpH • Keraservis • MODEL Box • PK Graphica • Reda • Rotschein Airbrush Model Shop • Sklenářství Rosprim
Veletržní výstavní servis • Web Facies • Wingscale CZ

MEDIA PARTNERS

Kagero • Letectví a kosmonautika • Modelář • Rádio Krokodýl • Radio R • Revi • SAM Publications • Super Model • Tamiya Model Magazine International